

1100mm HT. PLANTER
 SUN LOUNGER
 PLANTER POT
 FIRE BOWL
 LOUNGE 1
 CABANA STRUCTURE
 SOFA
 CABANA LOUNGE 1
 SUN BED
 SUN BED LOUNGE
 900mm HT. PLANTER
 DECORATIVE PAVING STRIP
 CHAIR
 CABANA LOUNGE 2
 WATER CASCADE
 SUBMERGED PLANTER POT
 OUTDOOR POOL
 REFLECTION POND

1100mm HT. PLANTER
 SECTIONAL SEATING
 DINING TABLES
 BARBECUE ISLAND WITH SINKS
 BBQ LOUNGE 1
 BBQ LOUNGE 2
 FLEX SPACE
 SCREEN
 900mm HT. PLANTER
 CASUAL SEATING
 LOUNGE 2
 OUTDOOR FITNESS AREA
 LARGE PLANTER POT WITH JAPANESE MAPLE
 DECORATIVE STONES

no.	revision	date	by
04	ISSUED FOR REZONING/SPA	2019-03-28	AF
03	ISSUED FOR REZONING/SPA	2018-12-17	AF
02	ISSUED FOR REZONING/SPA	2018-03-23	AF
01	ISSUED FOR REVIEW	2018-03-16	AF

CONTRACTOR MUST VERIFY ALL DIMENSIONS ON THE JOB AND REPORT ANY DISCREPANCY TO THE LANDSCAPE ARCHITECT BEFORE PROCEEDING WITH THE WORK.
 ALL DRAWINGS AND SPECIFICATIONS ARE INSTRUMENTS OF SERVICE AND THE PROPERTY OF THE LANDSCAPE ARCHITECT WHICH MUST BE RETURNED AT THE COMPLETION OF THE WORK.
 ALL DRAWINGS TO BE USED FOR CONSTRUCTION ONLY WHEN SIGNED BY THE LANDSCAPE ARCHITECT.

signed _____ date _____



20 Champlain Blvd. Suite 102 - Toronto ON - M3H 2Z1 info@terraplan.ca www.terraplan.ca



CLIENTS

11 YORKVILLE AVENUE
 TORONTO, ONTARIO

PROJECT
 3RD FLOOR OUTDOOR AMENITY PLAN

DRAWING
 DRAWN: AF
 CHECKED: JC
 SCALE: AS SHOWN
 DATE: 2019-03-28
 PROJECT NO.: 17-177



SHEET NO.: LS-101

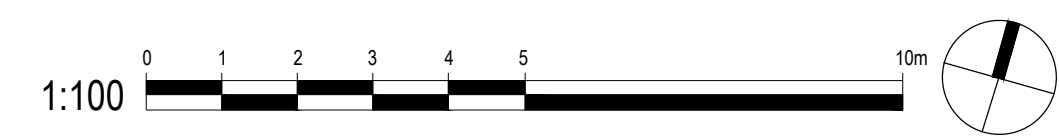

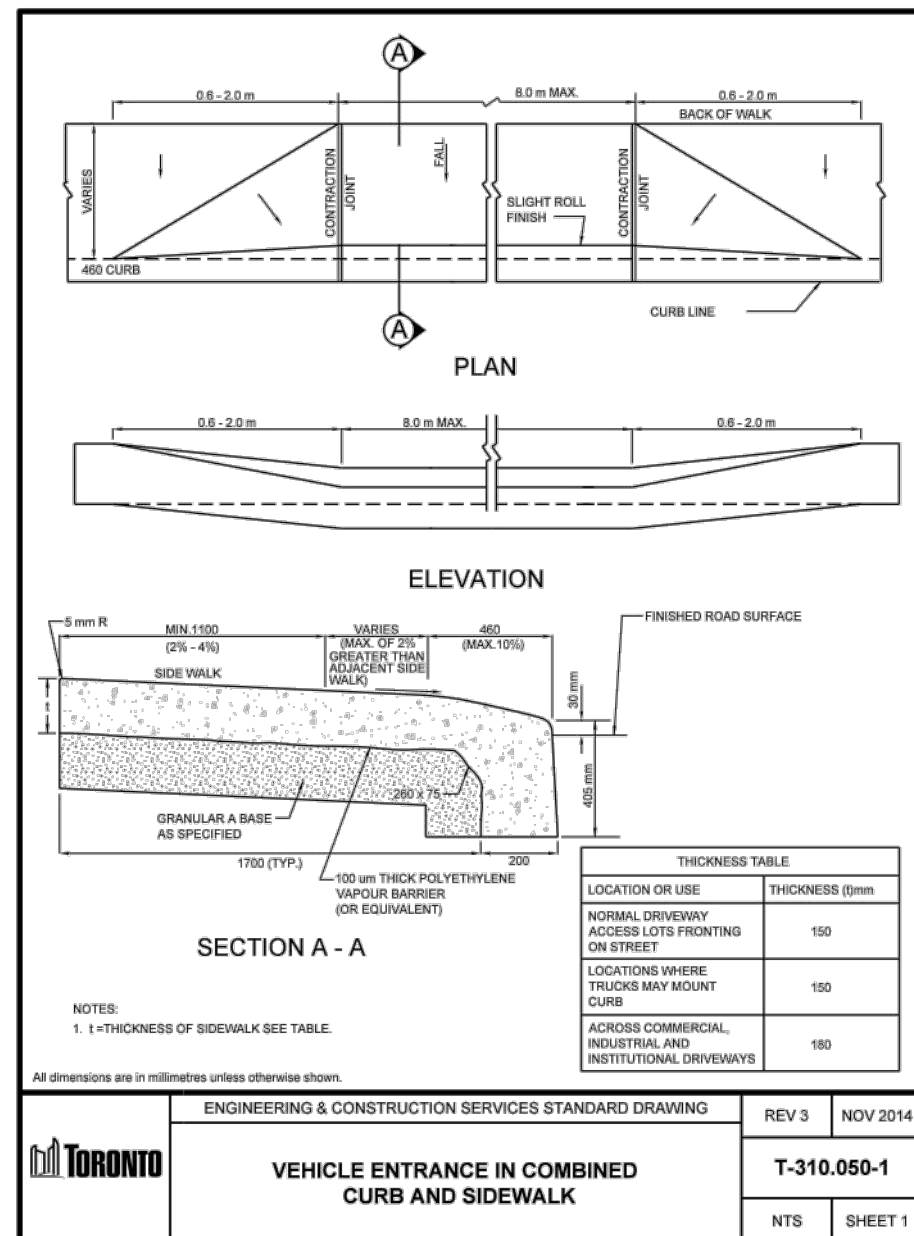

1 T-310.050-1

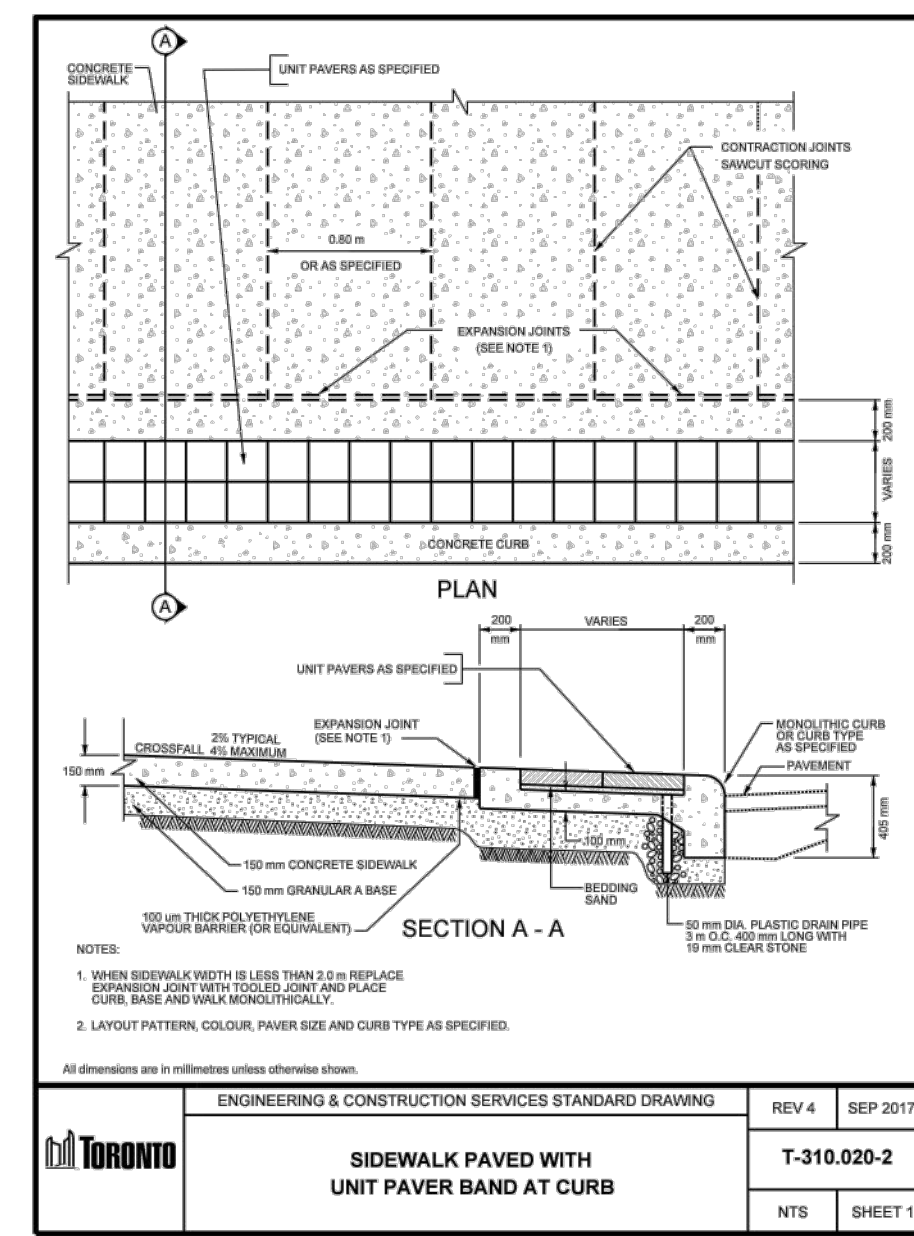

2 T-310.020-2

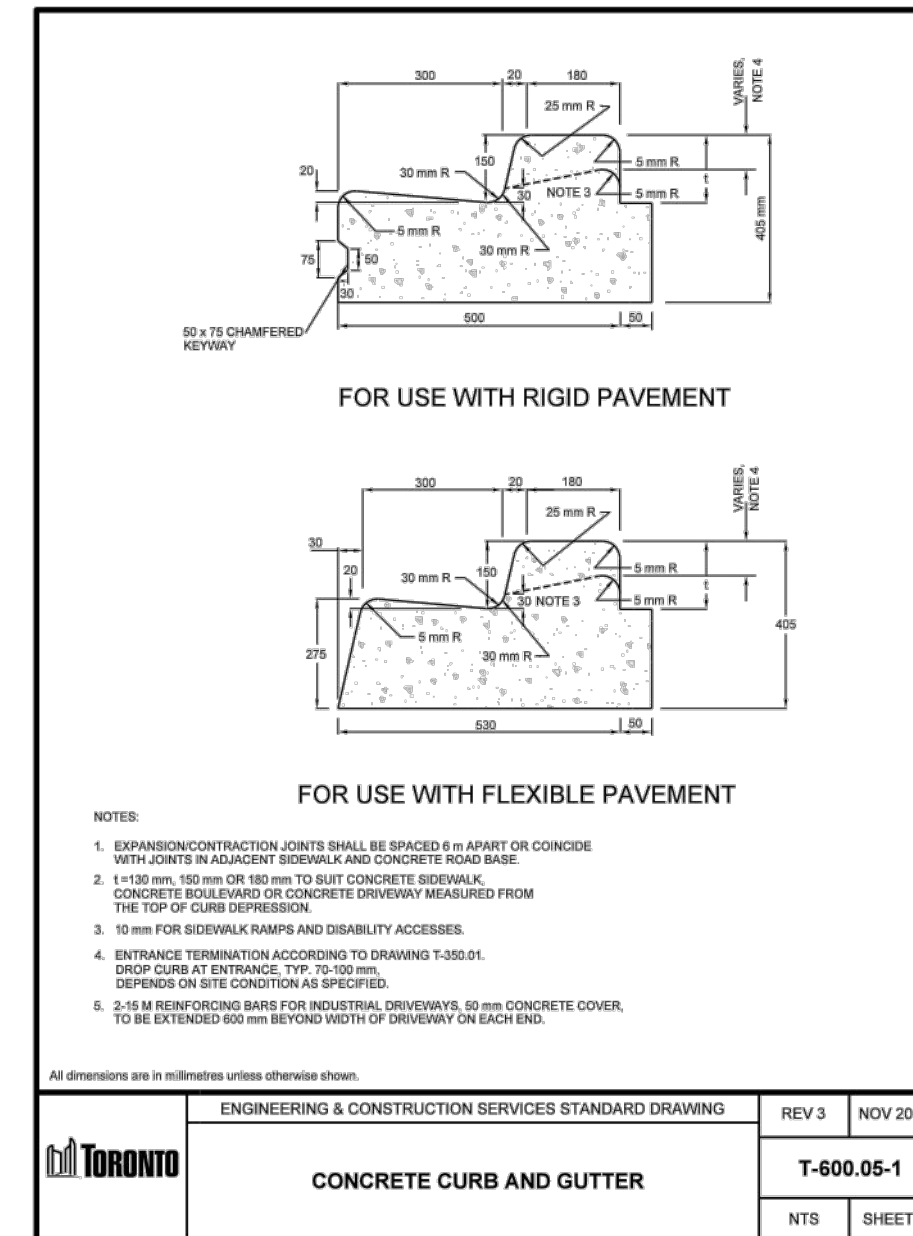

3 T-600.05-1

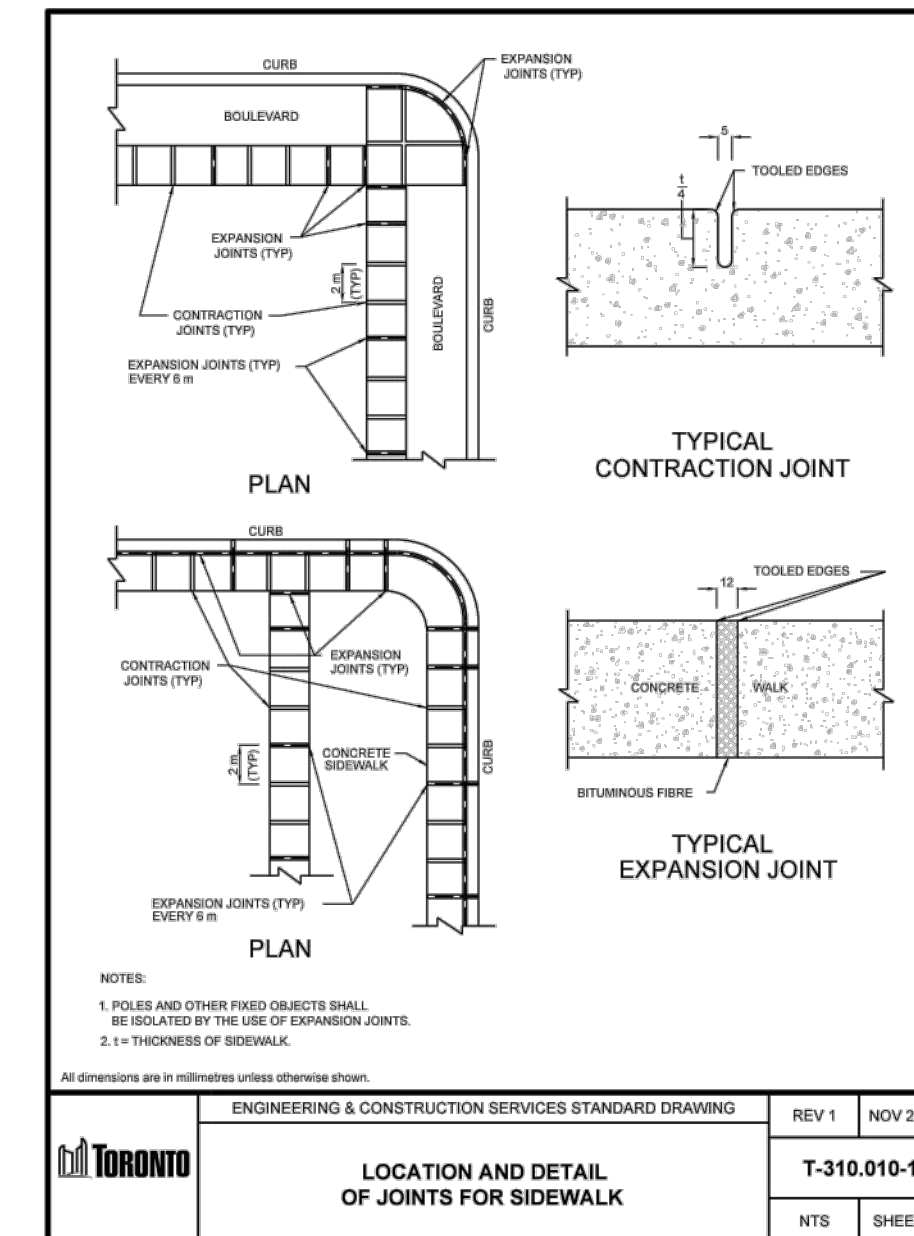

4 T-310.010-1

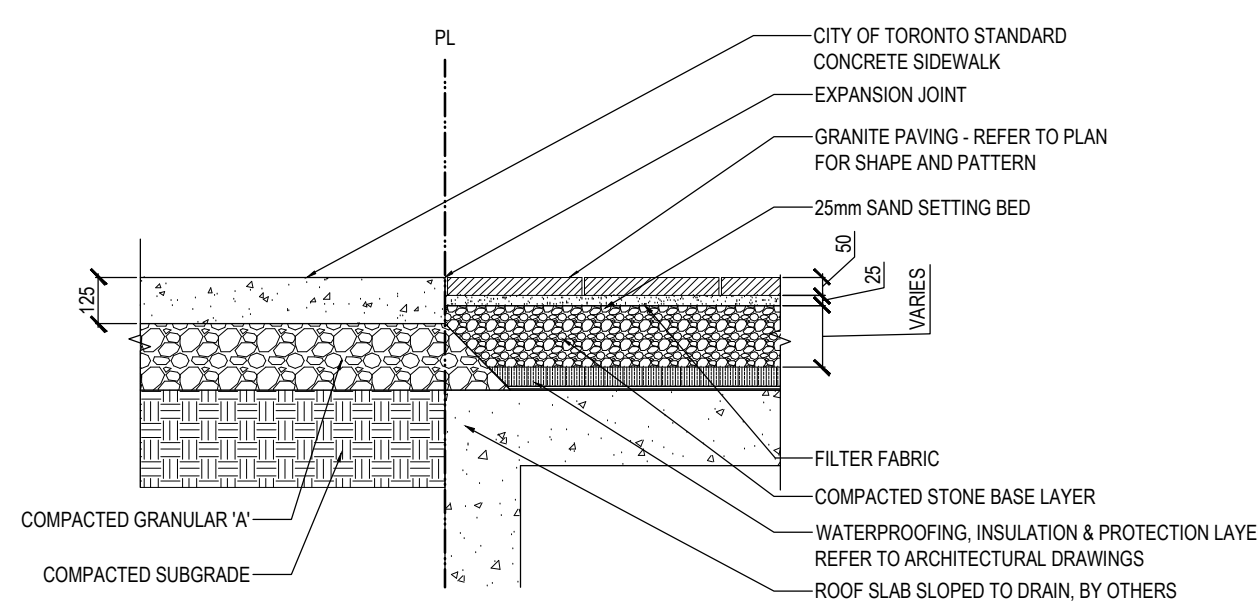

5 PAVING DETAIL ON/OFF SLAB
SCALE=1:20

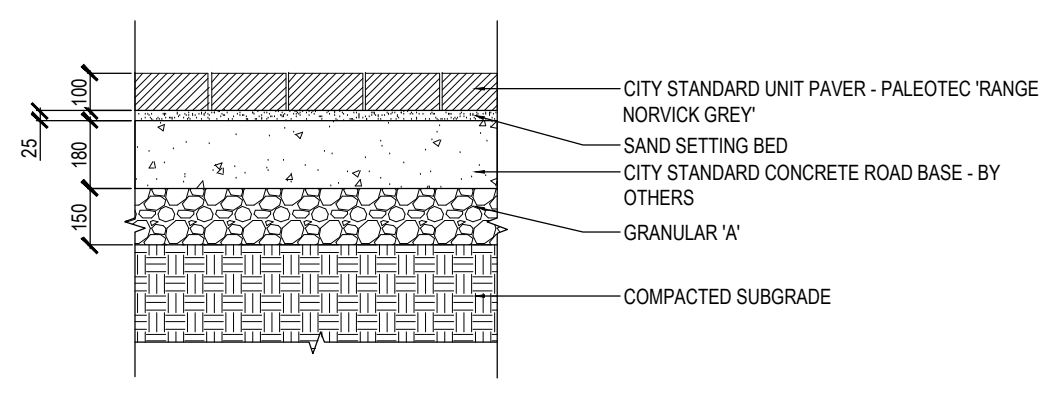

6 CITY STANDARD VEHICULAR UNIT PAVER
SCALE=1:20



DOG WASTE STATION (400 MUTT MITT SINGLES)
ITEM # 1005/1007
COLOUR: BLACK/WHITE
BY MUTT MITT OR APPROVED EQUAL

MANUFACTURER:
MUTT MITT
12316 WORLD TRADE DRIVE
STE 102
SAN DIEGO, CA 92128
PH: 602-487-0504
FAX: 659-689-5511
EMAIL: INFO@MUTTMITT.COM

7 MUTT MITT BAG STATION
N.T.S.

no.	revision	date	by
04	ISSUED FOR REZONING/SPA	2019-03-28	AF
03	ISSUED FOR REZONING/SPA	2018-12-17	AF
02	ISSUED FOR REZONING/SPA	2018-03-23	AF
01	ISSUED FOR REVIEW	2018-03-16	AF
	revision	date	by

CONTRACTOR MUST VERIFY ALL DIMENSIONS ON THE JOB AND REPORT ANY DISCREPANCY TO THE LANDSCAPE ARCHITECT BEFORE PROCEEDING WITH THE WORK.
ALL DRAWINGS AND SPECIFICATIONS ARE INSTRUMENTS OF SERVICE AND THE PROPERTY OF THE LANDSCAPE ARCHITECT WHICH MUST BE RETURNED AT THE COMPLETION OF THE WORK.
ALL DRAWINGS TO BE USED FOR CONSTRUCTION ONLY WHEN SIGNED BY THE LANDSCAPE ARCHITECT.

signed _____ date _____



20 Champlain Blvd, Suite 102 - Toronto ON - M3H 2Z1 info@terraplan.ca www.terraplan.ca



CLIENTS

11 YORKVILLE AVENUE
TORONTO, ONTARIO

PROJECT LANDSCAPE DETAILS

DRAWING
DRAWN: AF
CHECKED: JC
SCALE: AS SHOWN
DATE: 2019-03-28
PROJECT NO.: 17-177

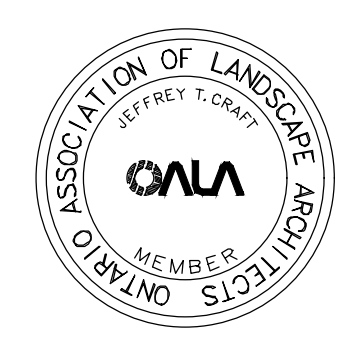

SHEET NO.: LD-100